

Galaxy HE MY23





















ISA S.p.A.

www.isaitaly.com



1.	NOTES / WARNINGS	4
1.1	COOLANTS	8
2.	MANUFACTURER	9
3.	GENERAL SALE TERMS	9
4.	IDENTIFYING THE EQUIPMENT	10
5.	SAFETY	11
6.	RESIDUAL RISKS	12
7.	DISPOSAL OF WASTE MATERIAL	13
8.	MAINTENANCE	14
9.	FAULTS - TECHNICAL ASSISTANCE - USER	15
10.	TECHNICAL ASSISTANCE	16
11.	STORAGE	16
12.	PROLONGED APPLIANCE SWITCH-OFF	16
13.	INSTALLATION	17
13.1	UNPACKING	17
13.2	ENVIRONMENTAL CONDITIONS	18
13.3	ELECTRICAL CONNECTION	18
13.4	POSITIONING - LEVELLING	19
13.5	WALL MOUNTING	20
13.6	DUCTING	21
14.	COMPOSITION	22
15.	USE	23
15.1	DISPLAY SHELVES LOAD LIMITS	23
15.2	BRACKETS	24
16.	TECHNICAL SPECIFICATIONS	25
16.1	TECHNICAL SPECIFICATIONS - FRONTAL VIEWS	26
16.2	TECHNICAL PLANS	28
17.	CONTROL PANEL	30
17.1	USER INTERFACE - XR77CH	31
17.2	USER INTERFACE - IR33	33
18.	CLEANING	35
18.1	INTERNAL	35
18.2	CONDENSER MAINTENANCE	36
18.3	DEFROST WATER COLLECTION TRAY (IF PRESENT)	36

The manual contains symbols to attract the reader's attention and highlight particularly important aspects. The table below illustrates the meaning of the various symbols used.

	Attention / hazard		Important information
	Earthing		Operations that must be performed by two people
	High temperature hot surfaces		Information
	Danger: Live electrical parts		Use of protective clothing
	Danger: Slipping		Eye check
	Danger: Tripping		Notes / warnings
	Danger: Flammable material		Waste disposal
	Danger: Explosion		Recyclable materials
	Read the manual		Sound pressure level
	Requests for maintenance or operations must be carried out by qualified staff or technical after-sales centres		

1. NOTES / WARNINGS



NOTE

The contents of this manual are of a technical nature and are the property of **ISA**. It is forbidden to reproduce, disclose or modify all or part of its contents without written consent. Any infringement will be legally pursued.

The manual and the conformity certificate are an integral part of the equipment and should always accompany the product in the event of a transfer to a new location or to a new owner. The user is responsible for the integrity of these documents, for their consultation and during the whole life cycle of the equipment itself. Keep this manual in a safe place. It should be available for consultation near the equipment at all times. If lost or destroyed, you can request a copy of the manual from **ISA** by specifying the exact model, serial number and year of manufacture. The manual reflects the manufacturing technology at the time of supply. The manufacturer reserves the right to modify its products in any way it deems necessary, with no obligation to update manuals and machines relating to previous manufacturing batches.

The equipment can be used by children no younger than 8 and by persons with reduced physical, sensory or mental capabilities, or lacking experience or necessary knowledge, as long as supervised or after having received training regarding safe use of the equipment and have an understanding of the inherent risks involved. Children must not play with the appliance. The cleaning and maintenance that the user will carry out must not be undertaken by children without supervision.

Always refer to this manual before going ahead with any operation. Before doing any type of work, disconnect the equipment from the power supply. Any work on electric and electronic parts or cooling system components should only be carried out by trained personnel in compliance with current laws.

The Manufacturer cannot be held liable for any damage to persons, animals or to the product in the following cases:

- Improper use of the equipment or use by unqualified or unauthorised personnel.
- Failure to comply with current legislation.
- Incorrect installation and/or power supply faults.
- Failure to observe the instructions contained in this Manual.
- Failure to follow the maintenance schedule.
- Unauthorised modifications.
- installation of non-original spare parts in the equipment.
- Installation and use of the equipment for purposes other than those for which the appliance was designed and sold.
- Tampering with or damage to the power supply cable.

Liability for applying the safety instructions contained in this manual is held by the technical personnel responsible for the intended use of the equipment, who should ensure that authorised personnel:

- Are qualified to carry out the requested activity.
- Are aware of and carefully comply with the instructions contained in this document.
- Are aware of, and apply, the general safety standards applicable to the equipment.

1. NOTES / WARNINGS



NOTE

The contents of this manual are of a technical nature and are the property of **ISA**. It is forbidden to reproduce, disclose or modify all or part of its contents without written consent. Any infringement will be legally pursued.

The manual and the conformity certificate are an integral part of the equipment and should always accompany the product in the event of a transfer to a new location or to a new owner. The user is responsible for the integrity of these documents, for their consultation and during the whole life cycle of the equipment itself. Keep this manual in a safe place. It should be available for consultation near the equipment at all times. If lost or destroyed, you can request a copy of the manual from **ISA** by specifying the exact model, serial number and year of manufacture. The manual reflects the manufacturing technology at the time of supply. The manufacturer reserves the right to modify its products in any way it deems necessary, with no obligation to update manuals and machines relating to previous manufacturing batches.

The equipment can be used by children no younger than 8 and by persons with reduced physical, sensory or mental capabilities, or lacking experience or necessary knowledge, as long as supervised or after having received training regarding safe use of the equipment and have an understanding of the inherent risks involved. Children must not play with the appliance. The cleaning and maintenance that the user will carry out must not be undertaken by children without supervision.

Always refer to this manual before going ahead with any operation. Before doing any type of work, disconnect the equipment from the power supply. Any work on electric and electronic parts or cooling system components should only be carried out by trained personnel in compliance with current laws.

The buyer is responsible for training personnel using the appliance on the risks, safety devices and general health and safety rules required by the laws of the country where the appliance is installed. Users/operators must be aware of the position of all the controls and how they work, as well as of the features of the appliance. They should also read this manual in its entirety. Maintenance work should be conducted by qualified personnel after the appliance has been prepared adequately.



DANGER

Unauthorised tampering or replacement of one or more parts of the appliance, use of accessories that modify the use of the same and use of spare parts different to those recommended, can become the cause of injury.



DANGER

Any work conducted on the appliance must involve disconnection from the power socket and in any case, none of the protective elements (grid, casing) should be removed by non-qualified staff. The appliance should not be operated when these protective elements have been removed. Before carrying out any cleaning, maintenance or replacement operation, disconnect the equipment from the mains by unplugging it from the electrical socket. During these operations the operator must be able to ensure that the plug remains disconnected.



NOTE

In order to avoid compromising the functionality and safety of the appliance, particularly complex installation and maintenance activities are not documented in this manual and must be performed by the undersigned company.

Never use electrical appliances inside this appliance. Do not use mechanical devices or other means to accelerate the defrosting process, other than those recommended by the manufacturer. Keep ventilation openings in the appliance's casing or in the recess free from obstruction. Do not damage the refrigeration circuit.



The A-weighted emission sound pressure level is lower than 70 dB(A).

RISK OF EXPLOSION



Do not store products containing combustible gaseous propellants and explosive substances in the equipment.

ISA uses materials of the best quality and as they enter the company, we constantly monitor their storage the use as part of the manufacturing process to prevent damage, deterioration and failure. All manufacturing elements have been designed and manufactured in order to guarantee high safety and reliability standards. All appliances are subjected to a strict testing procedure before delivery. However, please bear in mind that product performance over time depends on correct use and adequate maintenance. This manual contains the necessary instructions to maintain the appliance's initial appearance and functions over time. The use and maintenance manual contains the information required to understand the operating modes of the appliance and for its correct use, in particular: the technical description of the various functional units, accessories and safety systems, operation, use of instrumentation and interpretation of any diagnostic warnings, main procedures and information relating to the ordinary maintenance operations.

For correct use of the appliance, the working environment should comply with current health and safety standards.

The safety requirements, indications, standards and notes illustrated in the various chapters of the manual are aimed at establishing a code of conduct and a series of obligations to be observed when performing the various activities, in order to create safe conditions for personnel, the equipment and the surrounding environment.

The safety standards reported in this document are intended for trained, authorised personnel responsible for:

- Transport
- Installation
- Operation
- Management
- Maintenance
- Cleaning
- Decommissioning
- Disposal



ATTENTION

Reading this manual, albeit in full, is no substitute for adequate user experience. therefore it should only be considered as a useful reminder of the technical features and the main operations to perform.



WARNING

The installers and users must read and understand the instructions contained herein before performing any operation on the appliance.

STAFF TRAINING

The buyer is responsible for ensuring personnel who will use the appliance and maintenance technical staff are instructed and trained adequately. The manufacturer is available for advice, clarifications, etc. so that the operator and technical staff can use the appliance correctly. To ensure operator safety, appliance devices should be kept in constant working order. This manual is intended to illustrate the use and maintenance of the appliance. The operator has a responsibility and duty to carefully observe the instructions contained within it.

Failure to comply with safety standards may result in injury to personnel and damage to the equipment components and control unit. The user can contact the dealer to request additional information not contained in this document, or suggest improvements, at any time.



Before delivery to the customer, specialist technicians must check that the equipment is working properly to ensure that optimum performance is obtained.

1.1 COOLANTS

R744

The refrigerant is a gas that is compatible with the environment. Pay close attention during transport, installation and dismantling not to damage the refrigerant pipelines.

IN THE EVENT OF DAMAGE: Keep flames or ignition sources away from the appliance. Properly ventilate the premises for a few minutes. Switch off the appliance and unplug it.
INFORM CUSTOMER SERVICE.



ATTENTION High Pressure Cooling System.

Do not tamper with the system, but call a specialised and qualified technician before disassembly.



ATTENTION Maintenance must be performed by qualified personnel only.

R290

The refrigerant is a gas that is compatible with the environment but it is **highly flammable**. Pay close attention during transport, installation and dismantling not to damage the refrigerant pipelines.

IN THE EVENT OF DAMAGE: Keep flames or ignition sources away from the appliance. Properly ventilate the premises for a few minutes. Switch off the appliance and unplug it.
INFORM CUSTOMER SERVICE. The more refrigerant the appliance contains, the bigger the room in which the appliance is located must be. In areas too small, in the event of leakage can form a flammable mixture of air and gas.

The volume of the room where the appliance is installed must be at least 19 m³ for each cooling system present.



ATTENTION Maintenance must be carried out by technical personnel that is trained and qualified for interventions on flammable refrigerants.

R600a

Refrigerant **R600a** is a gas that is compatible with the environment but is **highly flammable**. Pay close attention during transport, installation and dismantling not to damage the refrigerant pipelines.

IN THE EVENT OF DAMAGE: Keep flames or ignition sources away from the appliance. Properly ventilate the premises for a few minutes. Switch off the appliance and unplug it.

INFORM CUSTOMER SERVICE. The more refrigerant the appliance contains, the bigger the room in which the appliance is located must be. In areas too small, in the event of leakage can form a flammable mixture of air and gas. **The volume of the room where the appliance is installed must be at least 17 m³ for each cooling system present in the room.**



ATTENTION Maintenance must be carried out by technical personnel that is trained and qualified for interventions on flammable refrigerants.

2. MANUFACTURER

ISA S.p.A. Via Madonna di Campagna 123
06083 Bastia Umbra - PG - Italy
T. +39 075 801 71
E. customerserviceisaitaly.com

3. WARRANTY TERMS AND CONDITIONS

The seller guarantees their equipment for a period of 12 (twelve) months from delivery. The warranty includes repairs or replacements of any faulty parts due to manufacturing processes or installation after written communication has been received, stating the appliance serial number and date of installation.

Not included in the warranty:

- Incorrect use of the appliance.
- Incorrect connection to the power grid.
- Normal wear of the components (such as breakage of the compressors, of the neon/LED lights, etc.) if not due to manufacturing defects.
- Calls for installation, technical instructions, adjustments, condenser cleaning.

If the seller's technical staff detect any tampering, unauthorised repairs or inappropriate use of appliance the warranty will be invalidated.

Shipment of components covered by the warranty is freight collect only.

Any damage to the appliance detected at the time of delivery due to transport must be reported on the same shipping note to claim compensation from the carrier.









The seller cannot be held liable in the event of damage to accepted products due to appliance faults.

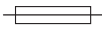



4. IDENTIFYING THE EQUIPMENT

Find the label affixed on the machine to read the technical data.

Check the machine model and the power supply voltage before you perform any operation.

If discrepancies are found, contact the manufacturer or the company that offer the supply immediately.

Identification of the company responsible for the product		Conformity marking		
Type		Model		
Article				
Manufacturing Date	Production order	Customer order	Climate class (*)	
Serial number - Series number		Property number - Series number		
Power supply voltage	Power supply frequency	Fuse Value	Lamp Power	Electrical resistance absorption
$V \sim$	Hz	 A	 W	 W
Nominal power	Power in defrosting	Pressure (minimum)	Pressure (maximum)	Safety class (EN 60335-2-89)
 W	 W	Psig	Psig	
Nominal current	Defrost current	Shelf load		Tank loading
 W	 W	Kg/m ²		Kg/m ²
Refrigerant type	Refrigerant weight	Gross volume		
		L		
1. Kg	Blowing agent		
2. Kg			
3. Kg			
It contains fluorinated greenhouse gases governed by the Kyoto protocol; hermetically sealed system.				

TEST CLIMATE CLASSES (*)				
	°C	% RH	°C	% RH
A	16	80	30	55
B	16	80	35	75
C	16	80	40	40
CC1	25	60	-	-
CC2	32.2	65	-	-
CC3	40.6	75	-	-
SN	10	-	32	-
N	16	-	32	-
ST	16	-	38	-
T	16	-	43	-
0	16	80	20	50
1	16	80	16	80
2	16	80	22	65
3	16	80	25	60
4	16	80	30	55
5	16	80	40	40
6	16	80	27	70
7	16	80	35	75
8	16	80	24	55

5. SAFETY

The appliance is equipped with safety devices. The buyer is responsible for training personnel using the appliance on the risks, safety devices and general health and safety rules required by the laws of the country where the appliance is installed. Users/operators must be aware of the position and operation of all the controls and features of the equipment and must also have read this manual in full.

SAFETY DEVICES INSTALLED

Devices whose operation prevents the occurrence of risk situations in operating conditions (e.g. fuses, pressure switches, protections, magnet circuit breakers, etc.).

FIXED GUARDS

Fixed protective devices consist of fixed perimeter guards, which are used to prevent external parts from entering the equipment.



DANGER

It is prohibited to re-start the appliance following maintenance without having correctly restored the panels.



VISUAL OBSERVATION

Periodically check the integrity of the fixed guards and the relative fixings to the structure with particular attention to the protection panels.

ISOLATING THE ELECTRIC POWER SUPPLY

Before performing any maintenance work on the equipment or on its parts, disconnect the relevant power supply.



DANGER

In the event of maintenance operations where the operator cannot prevent accidental closure of the circuit by others, completely disconnect the appliance from the mains electricity.

CIRCUIT FAULTS

Owing to potential faults, safety circuits may become less effective, which results in lower safety levels. You should check the operational condition of the appliance devices regularly.

WARNING SIGNS (IF ANY)

The equipment is fitted with danger, attention and obligation warning plates defined in accordance with the legislation on graphic symbols to be used on systems. The plates are located where they are clearly visible.



ATTENTION

Any warning plates on the appliance must not be removed.
The user is responsible for replacing warning signs that, owing to wear, become unreadable.

FALLING OBJECTS

Positioning of the cabinet display parts (where present) of the equipment (i.e. counters, rods and hooks, etc.), as well as the arrangement of the products inside the cabinet can be the source of potential hazards if not properly performed. Follow the positioning instructions described in this Manual before you place products inside the cabinet, check that the counters are properly fastened, as also the hooks, etc. Do not exceed the maximum load limit. Do not exceed the maximum load limit. Do not position tilted product on the counters if they are not held in place by their stoppers.

COOLING

During different operations to perform on the counter, such as cleaning or loading goods, it is necessary to handle products and/or counter parts at a low temperature with the risk of "cold injury" for the operators and/or accidental slipping hazard. Follow the safety regulations in the place where the cabinet is installed; more specifically, be sure to always use correct PPE (especially gloves).

FOOD SAFETY (PACKAGED PRODUCTS)

Direct contact between food products and the display surfaces does not occur when displaying packaged products, however, if product packaging is accidentally broken for a prolonged period of time, the product may become contaminated. If this occurs, strictly observe the instructions for use of the equipment (remove the damaged packaging from the display and clean with specific products).

6. RESIDUAL RISKS

During design the manufacturer examined all the areas or parts at risk. Therefore, all necessary precautions have been taken to prevent risks to persons and damage to the appliance.



ATTENTION

Periodically check that all safety devices are operating correctly.
Do not remove the fixed guards.
Do not introduce unauthorised objects or tools into the work area.

Although the appliance is fitted with the safety devices prepared, there are still some risks that cannot be eliminated, but reduced via corrective actions by the final integrator and correct operational procedures. Below is a summary of the remaining risks associated with the appliance during:

Normal operation.
Adjustment and fine tuning.
Maintenance.
Cleaning.

RISK OF CONTACT WITH LIVE PARTS

Risk of breaking or damaging the electrical components of the appliance, with a possible reduction in safety levels following a short circuit.

Before connecting the electricity supply, make sure there is no ongoing maintenance work.



ATTENTION

Before carrying out the connection, check that the d.c. current in the installation point does not exceed the value indicated on the protections switches present in the electric control board. If this is not the case, the user must provide the relevant limiting devices. It is strictly forbidden to conduct any electrical modification, in order to prevent additional unforeseen hazards and risks.

FIRE



DANGER

In the event of a fire, immediately disconnect the master switch from the main power supply line.

EXPLOSIVE ATMOSPHERE

The equipment must not be located in an area classified as an explosion risk according to 1999/92/EC such as:

Area:

- 0 An area in which there is a permanent, long-lasting or frequently explosive atmosphere made up of a mixture of air and flammable substances in the form of gases, fumes or steam.
- 1 An area in which the formation of an explosive atmosphere, made up of a mixture of air and flammable substances in the form of gases, fumes or steam is occasionally probable during normal activities.
- 20 An area in which there is a permanent, long-lasting or frequently explosive atmosphere in the form of clouds of combustible dust in the air.
- 21 An area in which there is a permanent, long-lasting or frequently explosive atmosphere in the form of clouds of combustible dust in the air.

SLIPPING



DANGER

Any leaks in the areas surrounding the appliance may cause personnel to slip. Check that there are no leaks and keep these areas clean at all times.

TRIPPING



DANGER

Generally, untidy deposits of material may constitute a tripping hazard and a total or partial obstruction of emergency exit routes. Ensure operational, transit and escape routes, free from obstacles, and comply with the current regulations.

7. DISPOSAL OF WASTE MATERIAL

During normal operation, the appliance does not generate any environmental contamination. At the end of its life cycle, or if it is necessary to proceed to permanent decommissioning, we recommend following the procedures below:

DISPOSAL

(USER)



The symbol, applied to either the product or its packaging, indicates that the product should not be considered as normal domestic waste, but should be taken to a waste collection point for the recycling of electrical and electronic appliances. The correct disposal of this product contributes to preventing potential negative consequences that might derive from an inadequate disposal of the product. For detailed information about recycling this product, contact your council, your local waste collection service or the store where you purchased the product.

PROCEDURE FOR DISPOSAL and RECYCLING AT THE END OF THE APPLIANCE'S SERVICE LIFE

(AUTHORISED BODIES)

- Switch off the equipment and unplug the power supply cable.
- Remove the lamps (if installed). These should be disposed of separately.
- Remove the power supply units and the electronic cards. These must be disposed of separately.
- Disassemble all the independent parts (grids, casings, profiles, etc.) and separate them by homogeneous material characteristics, in order to access the heat exchangers, pipes, cables, etc. being careful not to damage the refrigeration circuit.
- Remove all mobile parts (doors, sliding doors, glass parts, etc.) and group the various materials according to their similar characteristics.
- Check the type of refrigerant on the plate inside the counter; remove the refrigerant and dispose of it through the authorised services.
- Disconnect the evaporator, condenser, compressor, pipes and fans; the tubes being made of copper, aluminium, steel and plastic must be disposed of separately.
- After removing all the casings and the various components from the frame, separate the different types of material that compose them (plastic, sheet metal, polyurethane, copper, etc.) and group by homogeneous characteristics.



All recyclable materials and waste must be treated and recycled in a professional manner and in accordance with the directives of the country in question. The company assigned to recycling must be registered and certified as a waste disposal service according to the specific directives of the country in question.



ATTENTION

Illegal disposal of the product by the owner will result in the application of administrative sanctions provided by the laws in force. Disposal of the product should comply with current laws on the disposal of coolant liquids and mineral oils.



IMPORTANT

If the crossed-out wheeled bin symbol is not attached to the device, it means that the manufacturer is not responsible for disposal of the product; in this case, the current regulations on waste disposal always apply. Contact the competent municipal office, the local waste disposal service or the shop where the product was purchased.



ADDITIONAL INFORMATION

Further information on the disposal of liquid coolant, oils and other substances is available on the safety data sheet corresponding to the substance itself. In order to dispose of foamed assemblies, remember that the polyurethane foams used are CFC, HFC and HCFC free.

8. MAINTENANCE

The **Staff in charge of the appliance** must control and respect the expiry dates for maintenance, given in the table below, contacting the authorised **Technical Assistance** when indicated.

		FREQUENCY				Maintenance Manager	
		Depending on Use and Necessity	Monthly	Every 6 months	Annual		
Cleaning the external surfaces		●				<input type="checkbox"/>	USER
Cleaning the accessible internal parts	①	●				<input type="checkbox"/>	
Check integrity of sealing gaskets			●			<input type="checkbox"/>	
Control of power supply cable/plugs and/or electrical sockets				●		<input type="checkbox"/>	
Condensing unit filter cleaning	②			●		<input type="checkbox"/>	
Clean the collection tank of the water used to clean the inside of the tank	②	●				<input type="checkbox"/>	TECHNICAL ASSISTANCE
Condenser cleaning		●		●		<input type="checkbox"/>	
Check that the water inlet and outlet pipes are not leaking or damaged				●		<input type="checkbox"/>	
Check the compressor oil level	②			●		<input type="checkbox"/>	
Discharge the air tank	②			●		<input type="checkbox"/>	
Check pneumatic connections	②			●		<input type="checkbox"/>	
Check the integrity of chiller system piping				●		<input type="checkbox"/>	
Inspect cables and internal power connections				●		<input type="checkbox"/>	
Cleaning condensate drying sponges	②			●		<input type="checkbox"/>	
Clean the spray nozzle	②				●	<input type="checkbox"/>	
Replacing of lights / LEDS	②					<input checked="" type="checkbox"/>	
Replacement of control panel (Electronic control unit - thermostat - etc.)						<input checked="" type="checkbox"/>	
Replacing the power supply cable, plugs and/or electric sockets						<input checked="" type="checkbox"/>	

Routine Maintenance

Extraordinary Maintenance

① Without using tools

② If present



ATTENTION

After all maintenance it is **mandatory** to perform all electrical safety tests in accordance with the IEC EN 50106 Standard.

9. FAULTS - TECHNICAL ASSISTANCE - USER

If the appliance is not working properly or stops working, **before contacting the Customer Support Centre, perform the following checks according to the use of the appliance:**

THE APPLIANCE IS NOT WORKING

CAUSE	SOLUTION
Blown protective fuse	Previously find the cause of the intervention of the switch, and then re-introduce the new fuse.
The master switch is open	Close the master switch.
The plug is not inserted	Insert the plug.
Electrical black-out	If the black-out should continue for a long time, transfer the product to an appropriate refrigerator.

THE TEMPERATURE IS NOT LOW ENOUGH

CAUSE	SOLUTION
Wrong temperature setting	Set the appropriate temperature.
Equipment being struck by currents of air or exposed to direct or reflected sunlight	Remove any draughts and prevent any direct or reflected sunlight.
Insufficient air flow for cooling to the condenser	Remove anything that may affect air flow inside the condensing unit (paper sheets, cardboard, grids with an insufficient number of holes, etc.).

THE COMPRESSOR DOES NOT START-UP OR OPERATES FOR A FEW MOMENTS

CAUSE	SOLUTION
No electric power supply to the appliance	<ul style="list-style-type: none">• Check if there is a power cut.• Close the various switches on the power supply line.
Excessively low power voltage	Check that the network voltage of the power supply cable is of a rated value of 220V +/- 10%.
Set temperature too high	If the set temperature is higher than that of the air in the display compartment, the compressor is not activated. Set a more suitable temperature if the current value is not low enough.

THE TOUCH SCREEN DOES NOT REACT TO THE COMMANDS

CAUSE	SOLUTION
The display is dirty	<ul style="list-style-type: none">• Clean the display.• Switch the appliance off and on again.

THE FOOD DOES NOT REACH THE REQUIRED TEMPERATURE

CAUSE	SOLUTION
Incorrect cooling cycle setting	Check the program and make sure that the food is correctly distributed inside the cold room.
Incorrect distribution of the food on the trays	Check for anything obstructing the correct air circulation.
High thickness of the food	Reduce the thickness of the food.
Presence of cover or lid	Remove the cover or lid.

THE TEMPERATURE INDICATED BY THE PIN PROBE IS NOT CORRECT

CAUSE	SOLUTION
Incorrect insertion of the pin probe	Check that the pin probe is correctly inserted into the core of the product.
The pin probe is damaged	Use only timed or assisted programs. Contact the Technical Assistance Service for replacement.

10. TECHNICAL ASSISTANCE



THE TEMPERATURE IS NOT LOW ENOUGH

CAUSE	SOLUTION
High ventilation	
Internal fans at standstill or with fans damage	Replace the ventilators/fans.
Thermostat / Electronic control board not efficient	Replace the thermostat/electronic control board. If the electronic control board is used on appliances with R290 coolant, it must only be replaced with an original spare part supplied by the manufacturer. Replace the temperature probes only after checking which of the two is not operating efficiently.
Condenser clogged with dust or dirt in general	Clean the condensing unit thoroughly. In particular operating environments (e.g. presence of dust, presence of excessive humidity, etc.) when the performance of the equipment deteriorates, the condenser requires careful cleaning.
Insufficient refrigerant charge in the refrigeration system	Find the cause of the loss of coolant and eliminate it. Top up the coolant. If necessary, empty the system before topping up.

THE COMPRESSOR DOES NOT START-UP OR OPERATES FOR A FEW MOMENTS

CAUSE	SOLUTION
Intervention of the maximum pressure switch (where present)	Check the reasons for the continuous triggering of the maximum pressure switch, such as: <ul style="list-style-type: none">• Air condenser clogged.• Air condenser fan stopped.• Ambient temperature too high.• Pressure switch broken.

SPARE PARTS

<http://service.isaitaly.com/>

DATA BASE ENERGY LABEL

https://ec.europa.eu/info/energy-climate-change-environment/standards-tools-and-labels/products-labeling-rules-and-requirements/energy-label-and-ecodesign/product-database_en

ACCESS TO THE PROFESSIONAL REPAIR SERVICES

<https://www.isaitaly.com/it/assistenza/> ITALY Tel. +39 075 8017800 e mail: isaservice@isaitaly.com
ABROAD email: servicecall@isaitaly.com

11. STORAGE

The appliance, with or without its packaging, must be carefully stored inside warehouses or in areas protected from the weather and from direct sunlight, at a temperature of between **0** and **+40°C**.

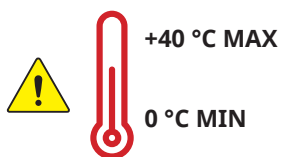

12. PROLONGED APPLIANCE SWITCH-OFF

Remove the product contained in the refrigerated compartment and place it immediately in a suitable refrigerated container to ensure proper storage. Open the equipment and wait for it to reach room temperature and then clean it. Leave the door/sliding panels open 2-3 cm such as to guarantee circulation of the air and to prevent the formation of mould and unpleasant odours inside the appliance. The appliance, with or without its packaging, should be carefully stored inside warehouses or in areas protected from the weather and from direct sunlight, at a temperature of between **0** and **+40°C**.

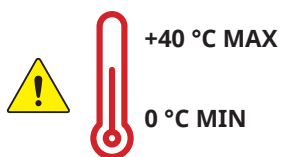

13. INSTALLATION

13.1 UNPACKING



Remove the packing from the appliance by removing the screws that fasten it to the pallet. All packaging materials are recyclable and should be disposed of in accordance with the local regulations. Please destroy "plastic" bags to prevent them from becoming hazardous to children (suffocation).



ATTENTION

Handling of the equipment must only be performed using a forklift truck of adequate power (with respect to the weight of the equipment) operated by qualified personnel: during this operation the equipment must strictly be positioned on the pallet supplied.

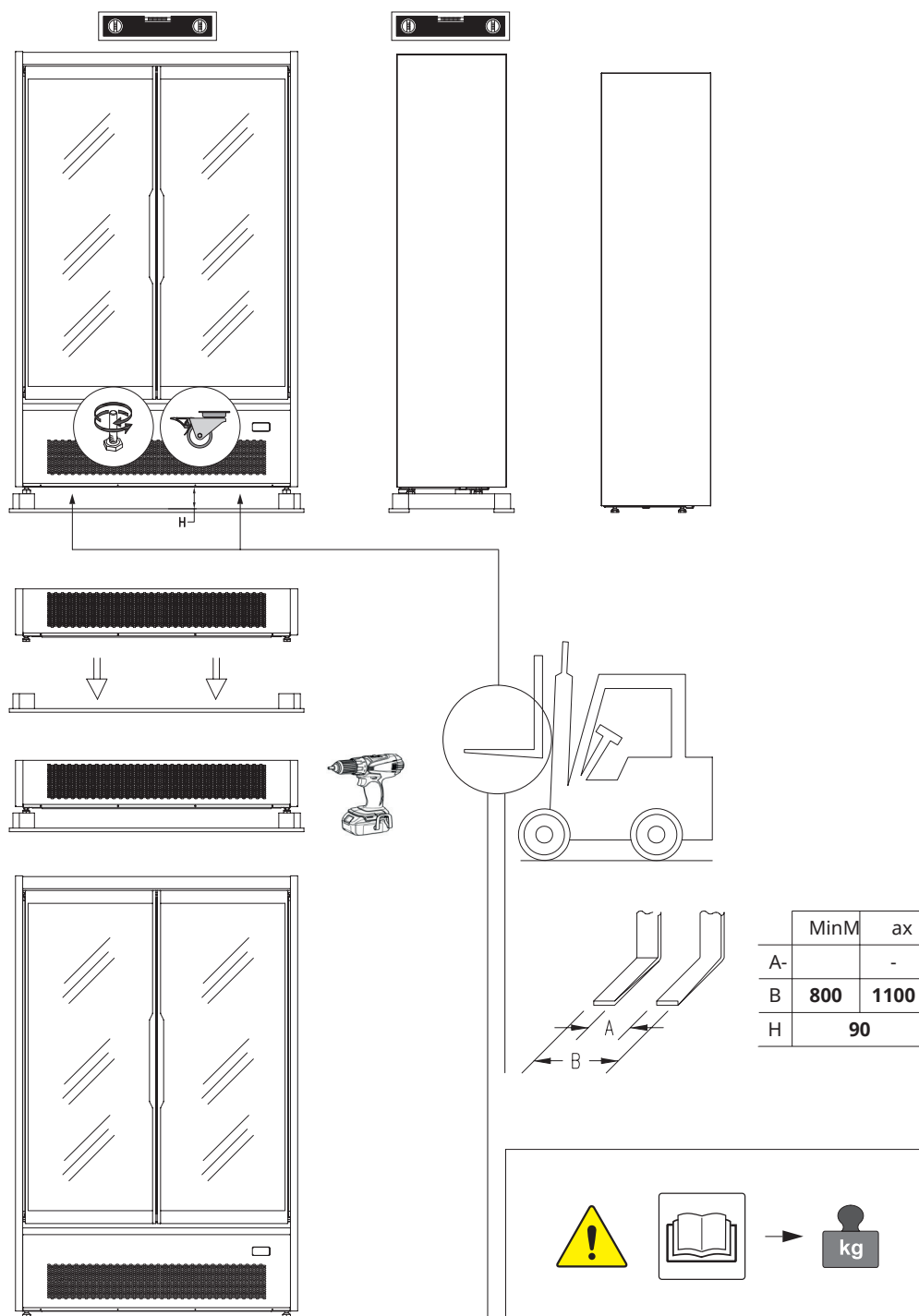

13.2 ENVIRONMENTAL CONDITIONS



ATTENTION

A dry room that can be ventilated is the suitable location for the appliance's installation.

There should be a good airflow around the compressor/condenser. Therefore the area around the unit should not be obstructed by boxes or other objects.

Place the equipment away from heat sources (radiators, heaters of any kind, etc.) and far from the influence of continuous air movement (caused by fans, air conditioning units, etc.).

If it is unavoidable to install near a heat source, use a suitable insulating plate.

Also avoid exposure to direct sunlight; all of this causes the temperature inside the refrigerated compartment to rise with negative consequences on operation and energy consumption.

Do not use the appliance outdoors and do not expose it to rain.

13.3 ELECTRICAL CONNECTION



ATTENTION

Check that the mains voltage corresponds to that indicated on the appliance rating plate and that the required power is adequate.

Check on the socket that the power supply voltage provides rated voltage ($\pm 10\%$) when you start up the compressor.

The plug should be directly connected to the electrical socket. It is forbidden to connect the plug to the socket by means of multiple socket extensions or adaptors.

The plant power supply socket must be fitted with a disconnecting device (dimensioned according to the load and in compliance with the standards in force), which guarantees complete disconnection in case of category III (3) over-voltage conditions and therefore protects the circuits against earth faults, overloads and short circuits.

Do not run the electricity cable in passageways.



ATTENTION

Remember that **earthing** is necessary and **is a requirement imposed by law.**

13.4 POSITIONING - LEVELLING

HEIGHT-ADJUSTABLE FEET / PIVOTING WHEELS WITH BRAKE

The equipment can be fitted with height-adjustable feet or pivoting wheels with brakes for floor stabilisation.



After positioning, it is **essential** to stabilise and level the appliance on the floor by acting on the adjustable feet as indicated.

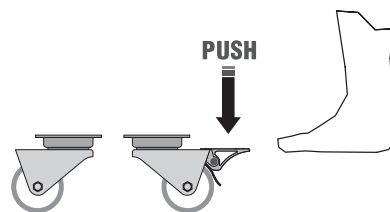
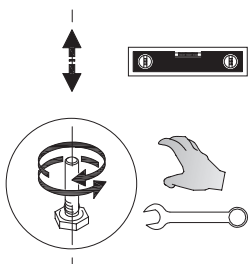
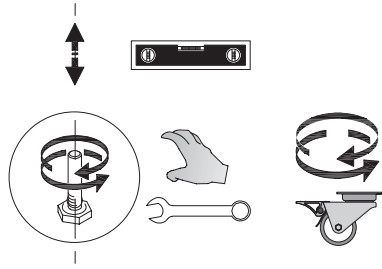

13.5 WALL MOUNTING



ATTENTION



For correct installation, it is essential to respect the distances indicated (mm).

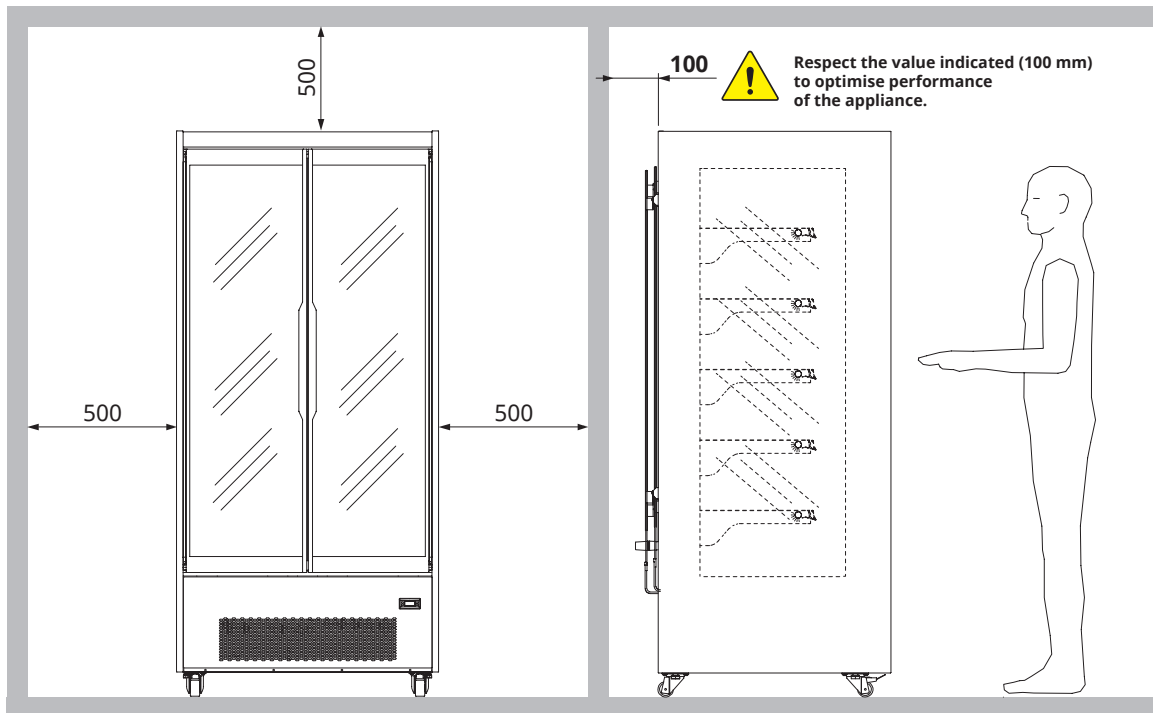

13.6 DUCTING

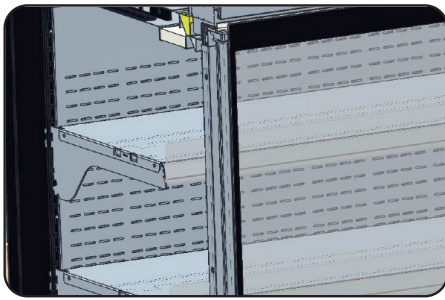

5 M5x40 screws

3

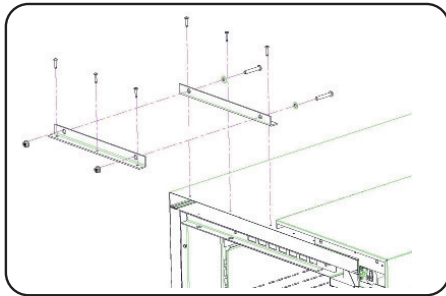
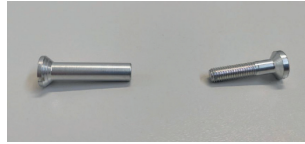

No. 2 M8x50 screws
No. 2 M8 nuts
2 washers 8.4x17x1.5
No. 6 M4.8x25 screws

2

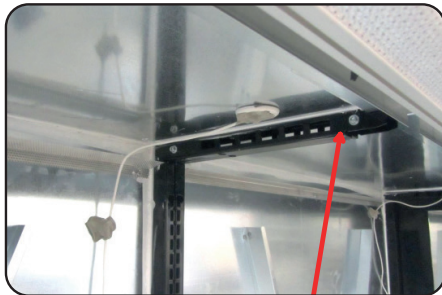

Additional coupling points
(only if necessary)

1 M6x80 screw
1 M6 nut
No. 1 washer 6.5x14x1.5

4

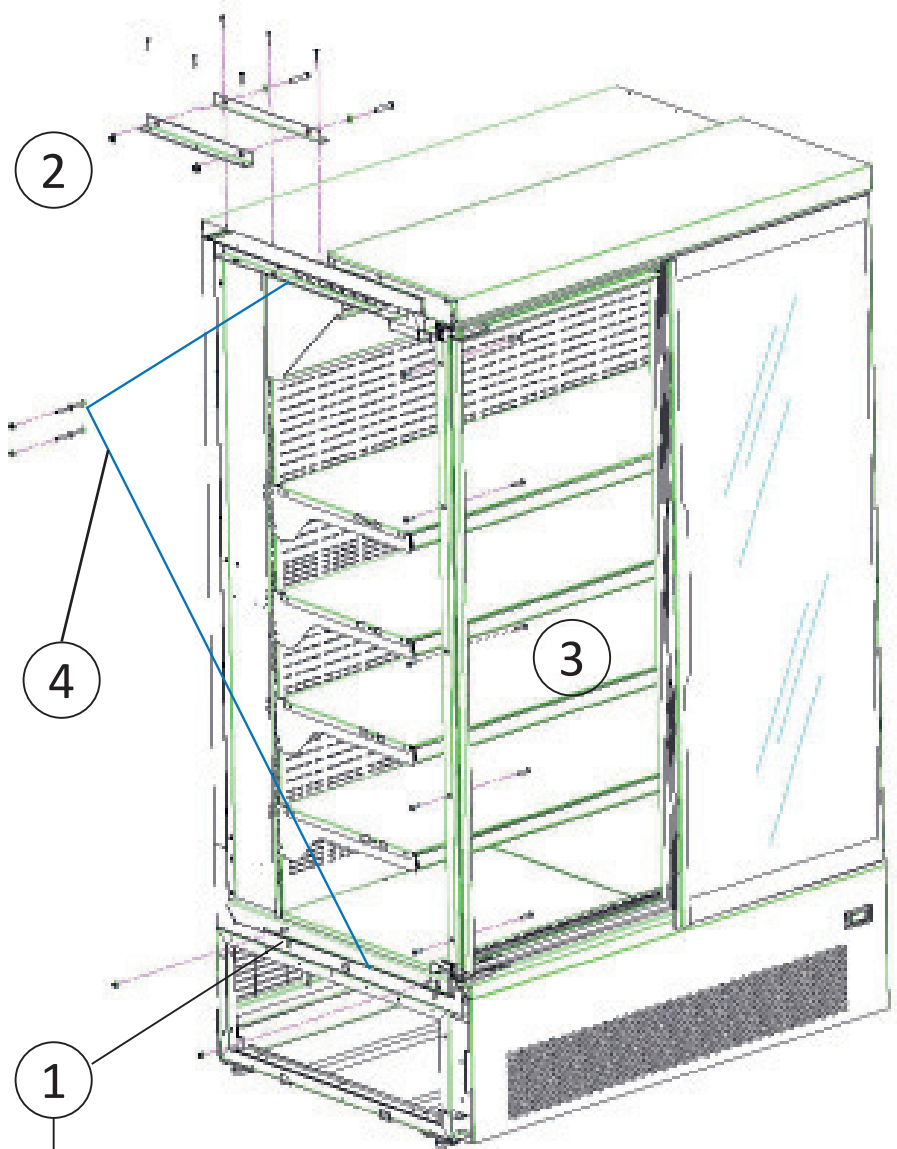

3

1

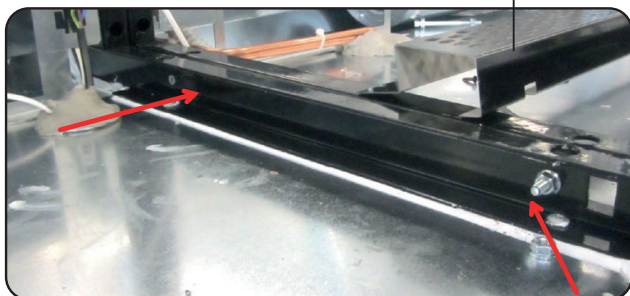

No. 2 M6x20 screws
No. 2 M6 nuts
2 washer 6.5x14x1.5

14. COMPOSITION

The appliance consists of a single unit on which all the functional devices necessary to make it a professional and efficient product for its intended use are assembled.

The appliance consists of:

Refrigeration	Ventilated
Installation	Plug-in - Extractable condensing unit
	Remote condensing unit (optional)
Control panel	Electronic
Adjustable display shelves	
Lighting	Vertical LED
Closing	Double glazed doors
Handling	Height adjustable feet
	Swivel casters with brake (optional)
Automatic system for condensed water evaporation	Plug-in only

15. USE

This equipment, based on the specific model, is used exclusively for the display and sale of:

SOFT DRINKS - CHEESES - DAIRY PRODUCTS - FRESH PRE-PACKAGED PRODUCTS

The manufacturer is not liable for injury to persons or damage to property or the appliance itself caused by the displaying of products other than those described above.

THE APPLIANCE IS INTENDED FOR PROFESSIONAL USE



Non-permitted uses:

- Preservation of products
- Displaying and/or preserving of non-food products (chemicals, pharmaceuticals, etc.).

15.1 DISPLAY SHELF LOAD LIMITS



ATTENTION



It is fundamental **not to exceed the load limits indicated** in order to avoid altering the correct air circulation and thus to prevent a high product temperature.

The limits indicated refer to a static and evenly distributed load; dynamic overloads due to violent loading operations, which must be avoided for safety reasons, are therefore excluded.

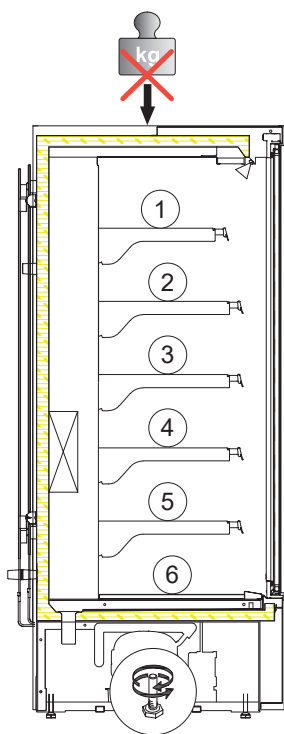
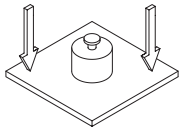

	94	125	188	250
①				
②				
③	66	86	125	160
④				
⑤				
⑥	70	94	140	175

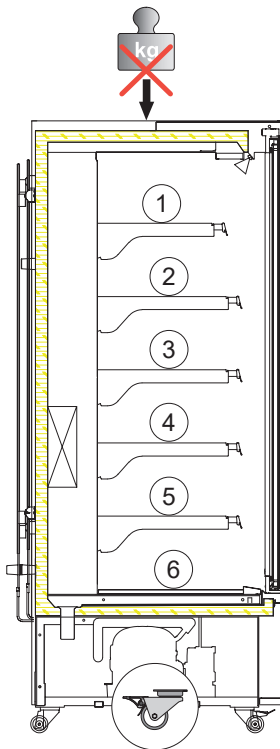

	94	125	188	250
①				
②				
③	60	49	103	89
④				
⑤				
⑥	64	54	115	101

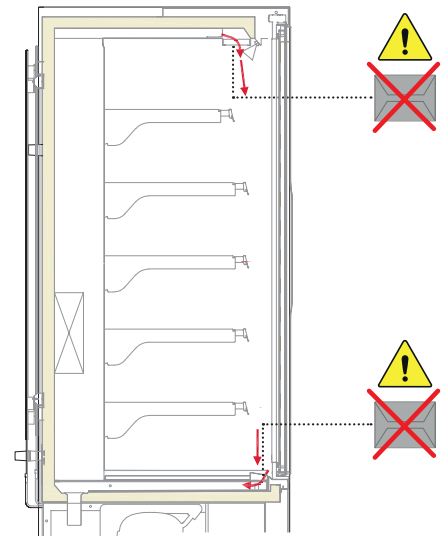

ATTENTION

It is **strictly forbidden** to obstruct the ventilation areas as indicated.

15.2 DISPLAY SHELF INSTALLATION



ATTENTION

It is **absolutely essential** to observe the maximum loads indicated for each shelf. The limits indicated refer to a static and evenly distributed load.

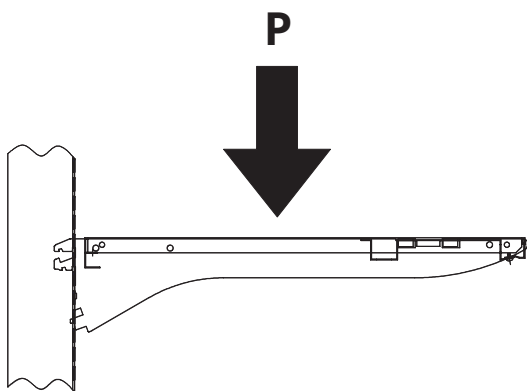
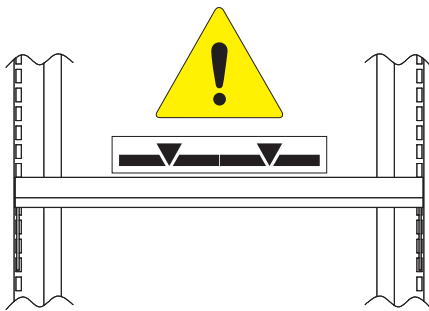
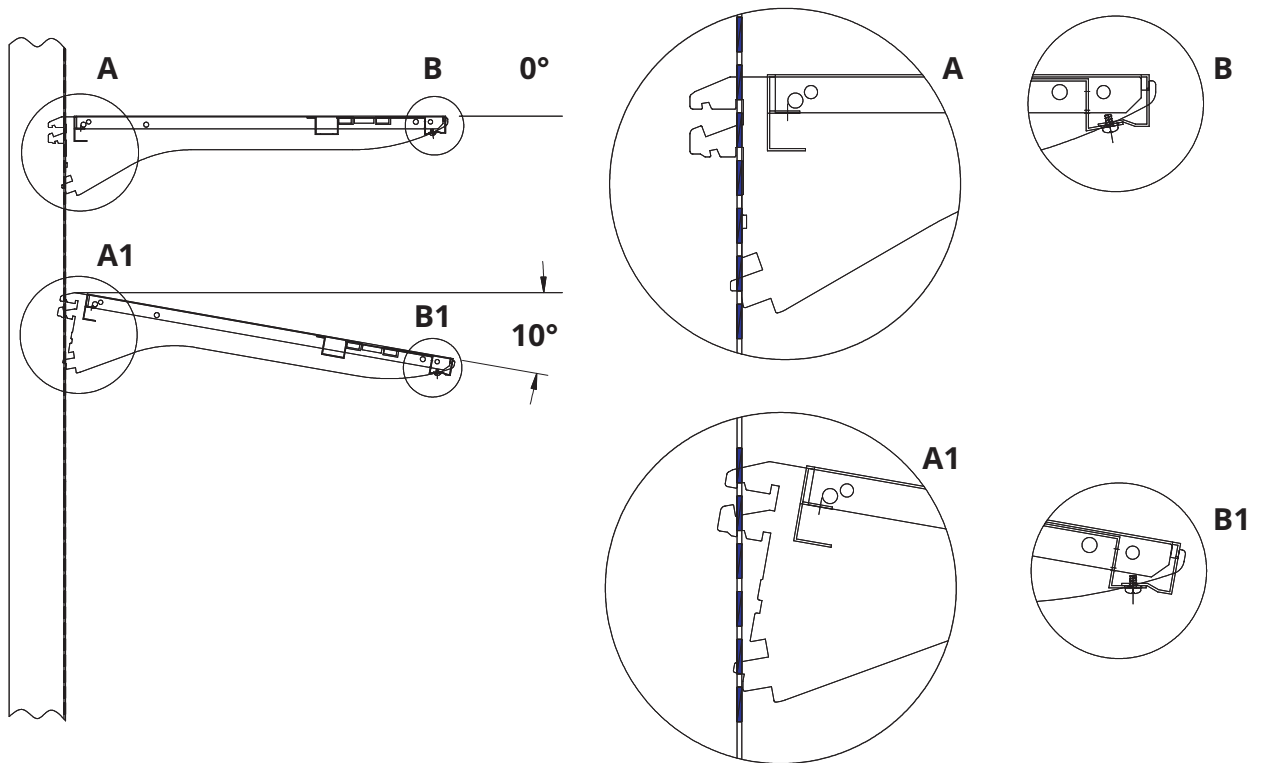

P max: 165 Kg/m²

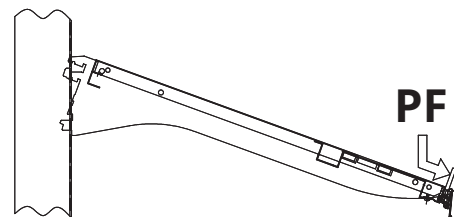

PF max: 10 Kg/m²

16. TECHNICAL SPECIFICATIONS

				Shoulders	94	125	188	250
External dimensions	Blind side walls	Length	mm		1011	1318	1953	2568
	Panoramic side walls	Length	mm		1025	1332	1967	2582
		Depth	mm		958 / 924			
	Adjustable feet	Height	mm		2054			
	Pivoting wheels	Height	mm		2123			
Weight	Blind side walls	Net	Kg		240	295	425	590
	Panoramic side walls	Net	Kg					
Display shelves				94	125	188	250	
External	Depth / Length		mm		400 x 940	400 x 1250	400 x 1880	400 x 2500
			mm		450 x 940	450 x 1250	450 x 1880	450 x 2500
			mm		505 x 940	505 x 1250	505 x 1880	505 x 2500

Height adjustable feet

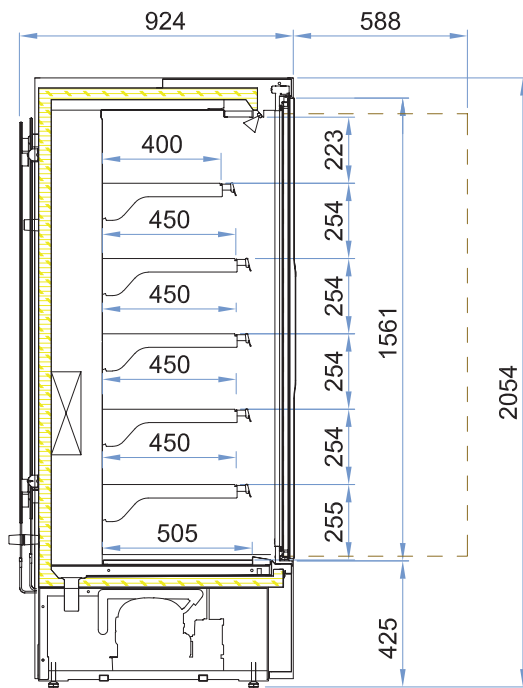
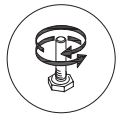

Swivel casters with brake (optional)

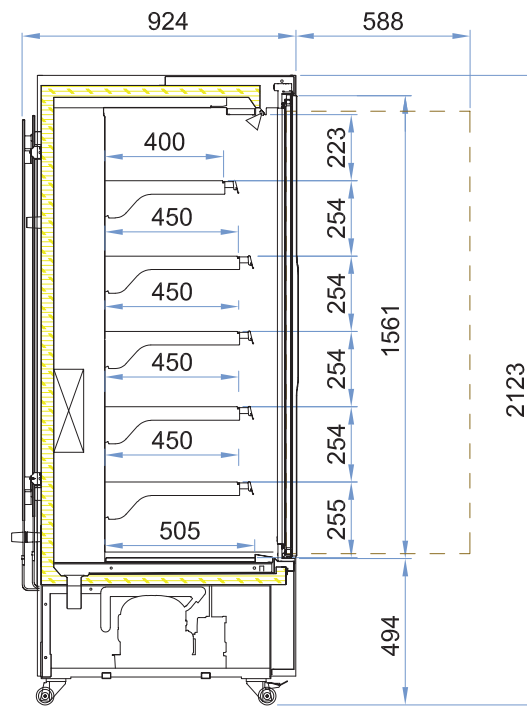

16.1 TECHNICAL SPECIFICATIONS - FRONTAL VIEWS

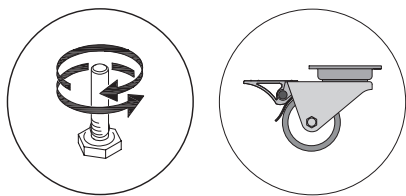

94

125

188

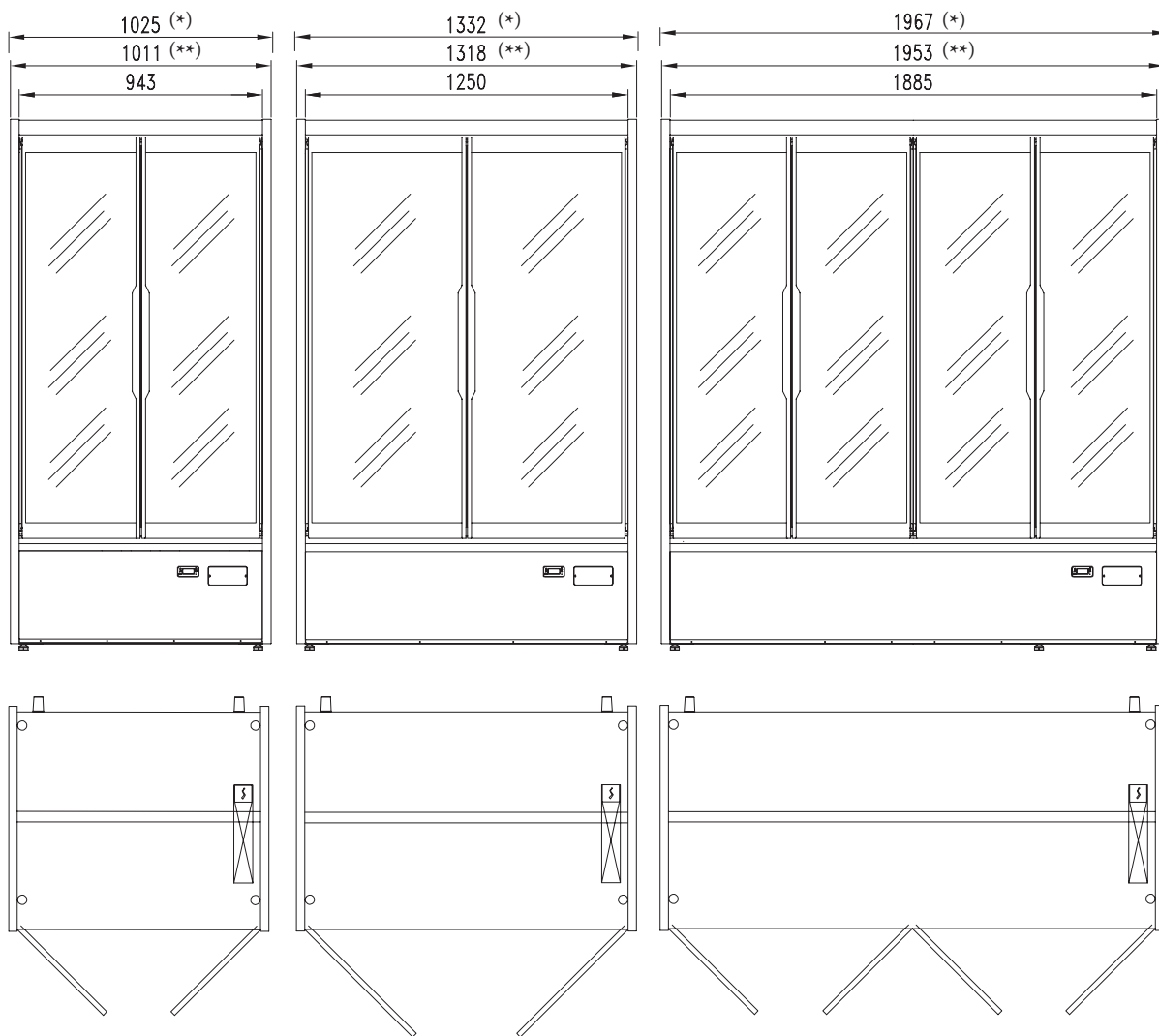

Shoulders

(*) **Panoramic side walls**

(**) **Blind side walls**

16.1 TECHNICAL SPECIFICATIONS - FRONTAL VIEWS

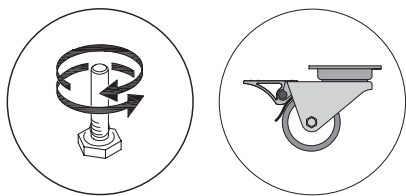

250

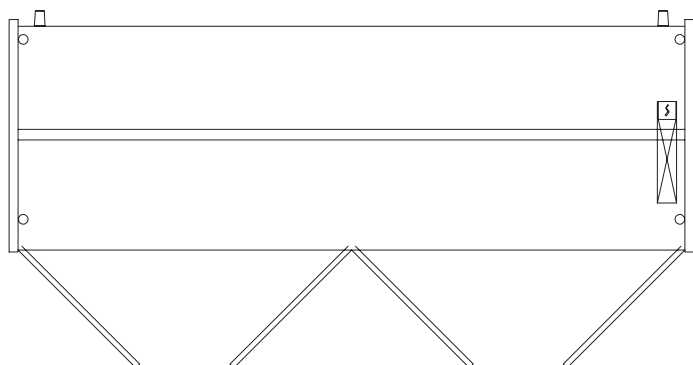
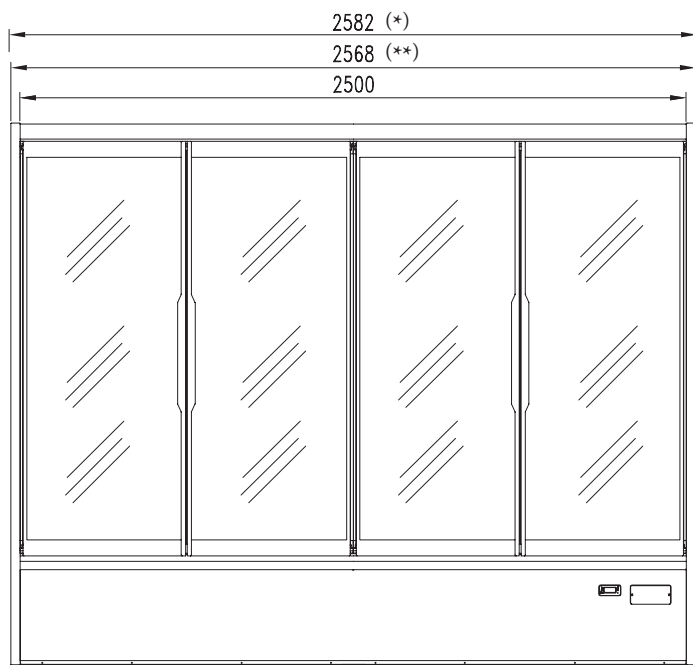

Shoulders

(*) **Panoramic side walls**

(**) **Blind side walls**

Panoramic Side Walls

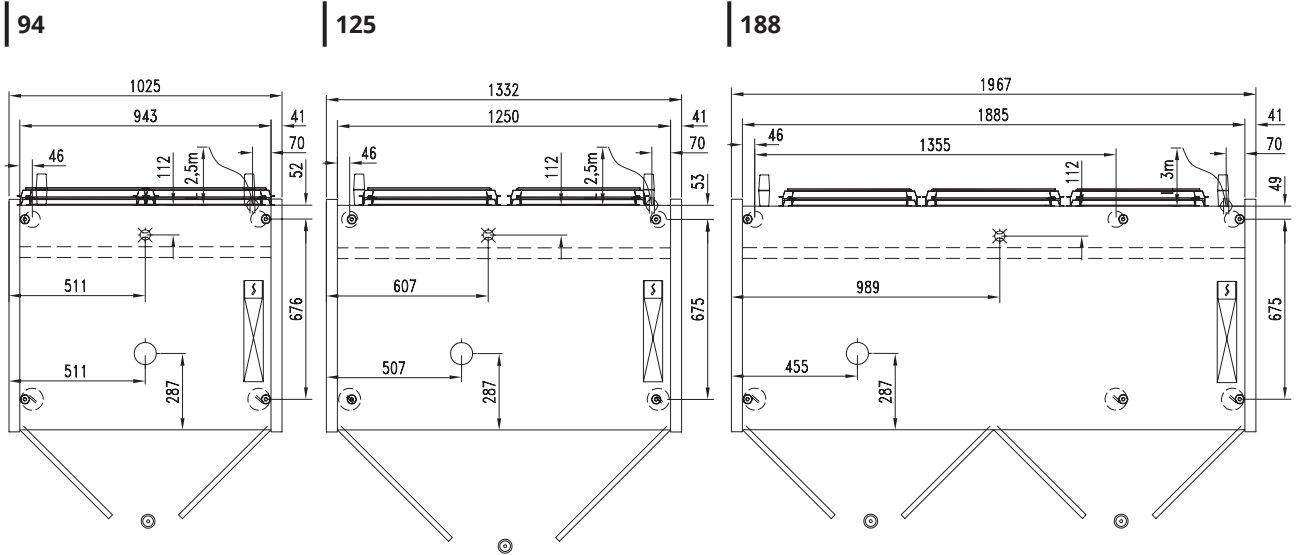

Blind Side Walls

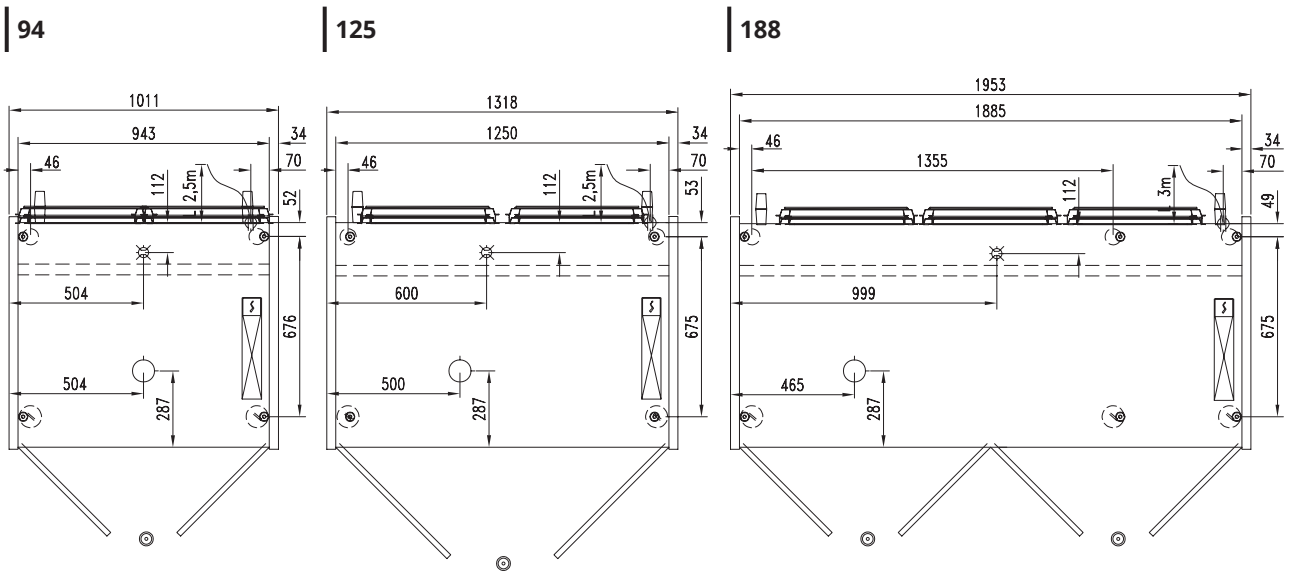

	SUPPORT FEET		32
	DISCHARGE		Ø 25 mm
	GAS CONNECTION		
	CABLE OUTPUT		
	CONTROL PANEL		
	WHEEL		
	WHEEL WITH BRAKE		
	CUSTOMER SIDE		
	PASSAGE OF PIPES THROUGH THE PLATFORM		

Panoramic Side Walls

250

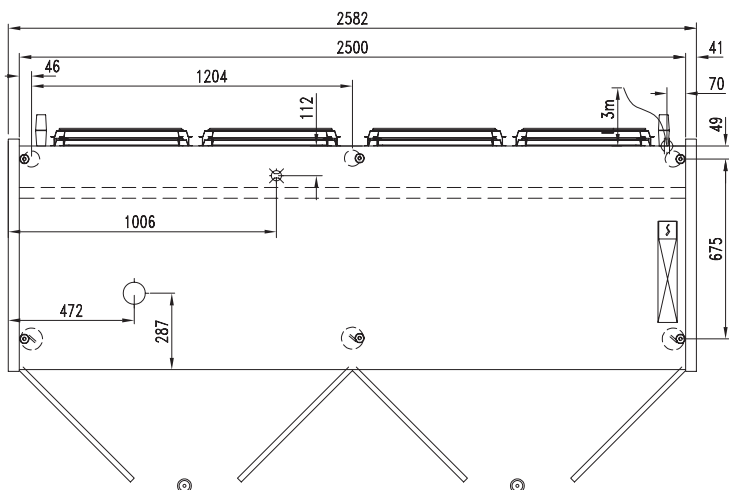

Blind Side Walls

250

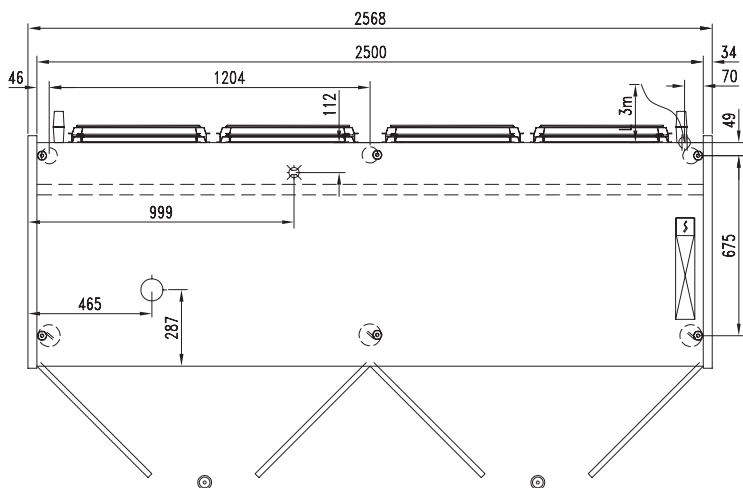

	SUPPORT FEET		32
	DISCHARGE		Ø 25 mm
	GAS CONNECTION		
	CABLE OUTPUT		
	CONTROL PANEL		
	WHEEL		
	WHEEL WITH BRAKE		
	CUSTOMER SIDE		
	PASSAGE OF PIPES THROUGH THE PLATFORM		

17. CONTROL PANEL

START-UP (ON)

Activate the mains system master switch.
Plug the appliance in the socket supplied by the customer, ensuring that the plug is fitted with an earth contact and that there are no multiple sockets connected to it.

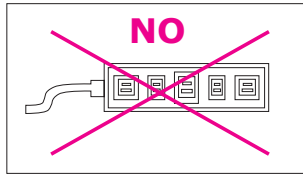
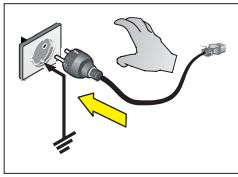

THE EQUIPMENT STARTS AUTOMATICALLY

POWER OFF (OFF)

Remove the power plug from the socket supplied by the customer.

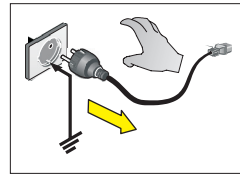

XR77CH



IR33



ATTENTION











The electronic control unit is installed already programmed; any changes to the control unit settings can only be performed by qualified technical personnel.

KEYS







SET-POINT

	DISPLAY Press and release the key: the SET-POINT will be displayed immediately; to go back to the temperature, wait 5 seconds or press the key again.
	CHANGE Press the key for at least 2 seconds; the SET-POINT will be displayed and the °C LED will start to flash.
	Use the UP and DOWN ARROW keys to change the value.
	To save the new set-point, press the SET key or wait 15 seconds to quit programming mode.







XR77CH**BUTTON SINGLE PRESS**

	<p>To view or edit the SET-POINT. While programming, select a parameter or confirm a value.</p>
	<p>DELETE MINIMUM/MAXIMUM TEMPERATURE When the stored temperature is displayed, keep the button pressed for a few seconds (the letters rSt appear). To confirm, the letters rSt will begin to flash.</p>
	<p>ARROW DOWN While programming, it scrolls through the parameter codes or decreases their value. When pressed for 5 seconds, it starts the defrost function.</p>
	<p>DISPLAY MINIMUM TEMPERATURE Press and release the key; the message "Lo" will be displayed, followed by the minimum temperature reached. Press the key or wait 5 seconds to display the normal temperature again.</p>
	<p>MANUAL DEFROST To start a defrost cycle, press and hold the DEF key for at least 2 seconds.</p>
	<p>ARROW UP While programming, it scrolls through the parameter codes or increases their value. When pressed for 5 seconds, it enables/disables ventilation depending on the setting.</p>
	<p>DISPLAY MAXIMUM TEMPERATURE Press and release the key; the message "Hi" will be displayed, followed by the maximum temperature reached. Press the key or wait 5 seconds to display the normal temperature again.</p>
	<p>Not applicable.</p>
	<p>ON/OFF When pressed for 5 seconds it turns the device on/off.</p>
	<p>Lighting ON / OFF.</p>

KEYS**COMBINED PRESSING**

 + 	<p>LOCK KEYBOARD Press and hold the keys for a few seconds until the word "POF" appears. At this point the keyboard is locked: only the set-point and the maximum and minimum temperatures can be viewed. If a key is pressed for more than 3 seconds, the word "POF" appears.</p>
	<p>LOCK KEYBOARD Press and hold the keys for a few seconds until the word "POn" appears.</p>
 + 	<p>To enter the programming function.</p>
 + 	<p>To exit the programming function.</p>





XR77CH

LED	ON	FLASHING
	Output active	<ul style="list-style-type: none"> • Programming. • Delay against close start-ups.
	Defrosting in progress	<ul style="list-style-type: none"> • Programming. • Dripping in progress. • Delayed fan start-up in progress.
	Temperature alarm	/
°C °F	Unit of measurement	Programming
	Fans on	Delayed activation in progress
eco	Energy saving in progress	/
	Continuous cycle in progress	/
AUX	Auxiliary relay active	/
	/	Fans stopped by key





ALARMS

Code	Cause
P1	Faulty temperature probe
P2	Faulty first evaporator probe
P3	Faulty second evaporator probe
HA	High temperature alarm
LA	Low temperature alarm
EA	External alarm
CA	External alarm (i1F=bAL)
	Pressure switch alarm (i1F=PAL)
oFF	Instrument in stand-by
dA	Door open
POF	Unlock door
POn	Keyboard locked











IR33**BUTTON SINGLE PRESS**

	If pressed for more than 5 seconds, it gives access to the "f" (frequent) type parameter setting menu. In the event of an alarm, the audible alarm (buzzer) is silenced and the alarm relay is deactivated.
	If pressed for more than 1 second,, it activates / deactivates the auxiliary output.
	If pressed for more than 5 seconds, it activates / deactivates a manual defrost.
	If pressed for more than 1 second, it displays and/or sets the SET-POINT.

KEYS SET-POINT

	DISPLAY Press and hold the Set key for at least 1 second - the set-point value will be displayed.
 	CHANGE To change the set-point value, use the UP and DOWN keys until the desired value has been reached.
	To confirm the new set-point value set, press the Set key again.









KEYS COMBINED PRESSING

 + 	If pressed for more than 5 seconds, it gives access to the menu for setting "c" type parameters (configuration) or to download documents.
 + 	If pressed for more than 5 seconds, any alarms with manual reset of the serial default are reset.
 + 	If pressed for more than 5 seconds, it activates / deactivates continuous cycle operation.
 + 	If pressed for more than 5 seconds, it activates the report printing procedure.
 + 	If pressed for more than 1 second, a submenu appears on the display with the HACCP alarm parameters (HA, HAn, HF, HFn).

ATTENTION

The pressing of each key is signalled by a short, non-deactivatable acoustic signal.

IR33**LED**

	FUNCTION	ON	OFF	FLASHING	START-UP
	Compressor	On	Off	Requirement	
	Fan	On	Off	Requirement	
	Defrost	In progress	Not required	Requirement	
AUX	AUX Auxiliary output	Active	Not active	Heater antisweat function active	
	Alarm	External	/	Alarms in nominal function (Example High / Low tempera- ture) or alarm from immediate or delayed external digital input	
	Clock	Timed defrost /		Alarm	ON if Real-Time Clock present
	Lighting Auxiliary output	Active	Not active	Heater antisweat function active	
	Assistance	/	None malfunction	Malfunction (Example EEPROM error or faults probe)	
HACCP	HACCP	Function not enabled	Function enabled (HA and/or HF)	HACCP alarm stored	
	Continuous Cycle	Function acti- vated	Function not acti- vated	Function required	
	Display				

18. CLEANING

The materials listed below must be cleaned as follows:

STAINLESS STEEL

Only use warm water and non-aggressive detergents and then rinse.

ACRYLIC / POLYCARBONATE

Wash with lukewarm water, using a soft cloth or a chamois cloth.

CURVED GLASS

Only use products specifically designed for cleaning glass.

It is advisable not to use tap water which could leave limescale residues.

18.1 INTERNAL



ATTENTION

Do not scrape ice from the walls with pointed tools, the surface could be damaged.
Do not use high pressure appliances (e.g. steam generators).

Remove the product from the refrigerated compartment and immediately place it in a suitable refrigerated holding cabinet to ensure proper storage.

Turn off the equipment.



Remove the manually removable accessories (e.g. sliding doors, grids, ice cream containers, etc.).

Wait at least 4 or 6 hours for any ice present on the evaporator to melt completely, before cleaning the equipment. We suggest, in this regard, to wait for the next day to make sure that defrosting is completed. Do not use mechanical devices or other means to accelerate the process of defrosting other than those recommended by the manufacturer.

Remove (if present) the drain plug at the bottom of the tank to drain the defrosted water. It is recommended to apply a rubber tube or other suitable material in the drain hole in order to facilitate the exit of liquids.



ATTENTION

For the correct operation of the appliance make sure that the drain plug is reinserted correctly and completely after cleaning.

Clean the side panels and the bottom of the tank using a mild detergent, warm water and a cloth or a non-abrasive sponge. Do not use sharp tools. Rinse thoroughly and dry with an absorbent cloth.

If the appliance is connected to a drain on the ground, run lukewarm water containing a sanitising solution suitable for the specific use. The quantity of solution to be used must be such as to ensure one perfect removal of any product residues and proper sanitation along the entire drainage path.

If the appliance is not connected to a ground drainage, follow the procedure described in the previous point. The rinse water collected in the tank will be positioned inside the base of the appliance. Proceed to also clean and disinfect the collection tray.

Refit the accessories previously removed.

Turn on the equipment.



Let the appliance cool down until it reaches the desired temperature before reintroducing foods.

18.2 CONDENSER MAINTENANCE



Turn off the appliance and wait a few hours until all the condensing unit appliances have reached a temperature that is close to room temperature.

ATTENTION

Cleaning should be carried out according to use and necessity in observance of the maintenance schedule.

FREQUENCY

- Depending on use and necessity
- Every six months

A dirty condenser will negatively affect the efficiency of the appliance and drastically decrease its performance.

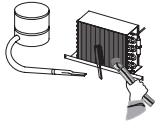

Clean the condensing unit using a dedicated soft bristle brush and a vacuum cleaner; carry out the operation taking care not to bend the condensing unit springs.

18.3 DEFROST WATER COLLECTION TRAY (IF PRESENT)

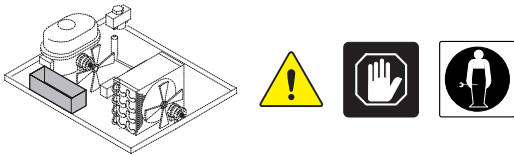

Clean based on use and as needed and in certain environmental conditions (e.g., high humidity, low environmental temperature, presence of dust, etc.) in order to avoid the incorrect and complete evaporation of the water and/or the presence of unpleasant odours.

Sanitise the tray with specific products.



ISA S.p.A.

via Madonna di Campagna 123
06083 Bastia Umbra (PG)
Italy

T. +39 075 801 71

E. customerservice@isaitaly.com

www.isaitaly.com