



IL·CARRETTINO  
DEI·GELATI







# Il gelato PRÊT-À-PORTER

Il Carrettino di ISA è un autentico tributo agli antichi carretti dei gelati che riempivano di allegria e felicità le strade di paese fino a diventare nel tempo un'icona del gelato tradizionale italiano in tutto il mondo.

.....  
The ISA cart is an authentic tribute to the ice cream carts of long ago that filled the streets of the country with joy and happiness becoming in time an icon of traditional Italian ice cream throughout the world.

.....  
Le Petit triporteur d'ISA est une authentique référence aux anciens triporteurs de glaces qui remplissaient de gaieté et de bonheur les rues des villages jusqu'à devenir au fil du temps, une icône de la glace traditionnelle italienne dans le monde entier.

.....  
Die Carrettino von ISA ist eine echte Ehre zu den alten Eiswagen erwiesen, der mit Freude und Heiterkeit die Straßen der Dörfer füllte. Bis er mit der Zeit ein Symbol des traditionellen italienischen Eises in der Welt wurde.

.....  
El "Carrettino" de ISA es un auténtico tributo al antiguo carrito de helados que llenaba de alegría y felicidad las calles del pueblo hasta volverse con el tiempo un ícono del helado tradicional italiano en todo el mundo.



# Il Carrettino CLASSICO

Atmosfera d'altri tempi ma tecnologia all'avanguardia per una grande efficienza in qualsiasi condizione: scocca monolitica coibentata con poliuretano ecologico (HCFC e HFC free) espanso a CO<sub>2</sub>, unità condensatrice a bordo a refrigerazione ventilata, interno vasca e piano di servizio in acciaio inox.

Il Carrettino è la soluzione ideale per installazioni free-standing e vendite promozionali outdoor.

4

.....

A nostalgia for the past combined with cutting edge technology for great efficiency under all conditions: a monolithic structure insulated with eco-friendly CO<sub>2</sub>-blown polyurethane foam which is HCFC and HFC free, an on-board condensing unit with ventilated refrigeration, and a basin and countertop of stainless steel. The cart is the ideal solution for free-standing installations and outdoor sales promotions.

.....

Eine Stimmung aus dem vergangenen Zeitalter, aber eine bahnbrechende Technologie für eine große Effizienz unter allen Bedingungen: Monocoque isoliert mit umweltfreundlicher Schaumstoff aus Polyurethan (HCFC und HFC free), luftgekühlter eingebauter Kondensator, Wanne und Arbeitsplatte aus Edelstahl. Die „Carrettino“ ist die ideale Lösung für freistehenden Installationen und Outdoor Verkaufsförderungen.

.....

Atmosphère d'une autre époque, mais avec une technologie à l'avant-garde, qui fait preuve d'une grande efficacité en toute condition: coque monolithique isolée avec polyuréthane écologique, HCFC et HFC free, répandue au CO<sub>2</sub>, unité condensatrice incluant la réfrigération ventilée, vasque intérieure et plat de service en acier inox. Le petit triporteur est la solution idéale pour des installations free-standing et des ventes outdoor promotionnelles.

.....

Atmósfera de otros tempos pero con tecnológica vanguardia y con eficiencia para cualquiera condición: cuerpo monolítico aislado con poliuretano ecológico (HCFC y HFC free) expandido a CO<sub>2</sub> unidad de condensación a bordo con refrigeración ventilada, el envase interno y la mesa de trabajo en acero inoxidable. El "Carrettino" es la solución ideal para ubicaciones independientes y ventas al exterior.









ISA

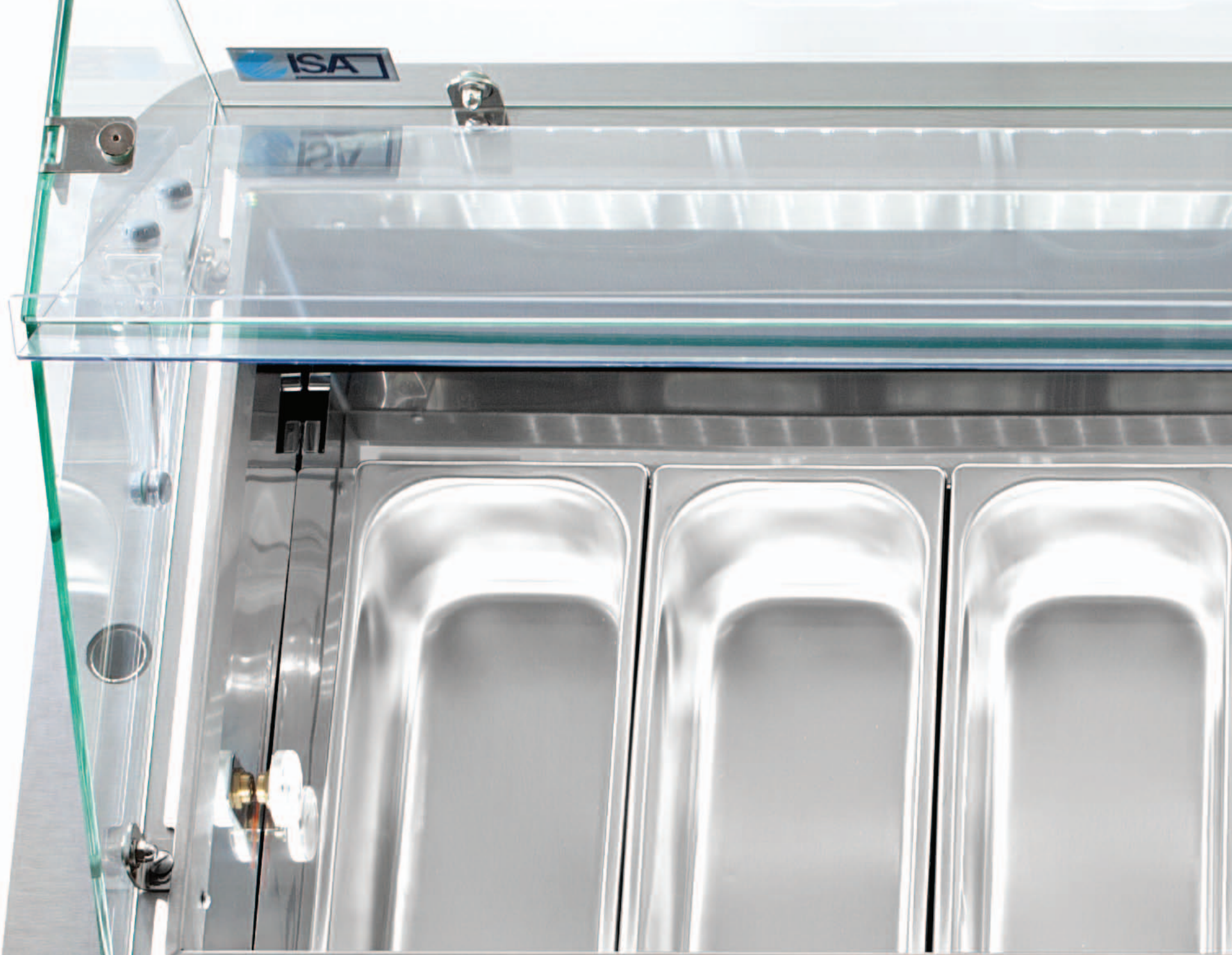

A stainless steel cart with three compartments and a glass top. The cart is shown from a side-on perspective, highlighting its polished metal surface and the clear glass top. The compartments are empty and have a rounded, rectangular shape. The glass top is held in place by metal brackets and bolts. The cart is set against a light-colored background.

Il Carretto  
CLASSICO

7



# Il Carrettino =CARAPINE=

Il Carrettino Carapine è la nuova reinterpretazione del tradizionale carretto refrigerato a pozzetti che condivide con il Carrettino Classico la filosofia costruttiva e il design retrò con in più il sistema a pozzetto e carapine che permette un'ottima conservazione del gelato e una ottima stabilità della temperatura del prodotto soprattutto in situazioni di temperatura e umidità particolarmente impegnative.

8

.....

The Carapine Cart is a new interpretation of the traditional refrigerated cart that shares with the Classic Cart its philosophy and retro design and has the additional advantages of a well counter with circular tubs that allow for excellent ice cream storage and a greater temperature stability of the product, especially in conditions where the temperature and humidity are especially challenging.

.....

Die „Carrettino Carapine“ ist die neue Interpretation des traditionellen Eiswagens mit Brunnen, der mit dem klassischen Eiswagen die Bauweise und den Retrò Design teilt, aber die Vorteile des Brunnen und Carapine Systems hat, welcher eine hervorragende Haltbarkeit des Eises und eine größere Temperaturstabilität ermöglicht, besonders in schwieriger Lagen von Temperatur und Feuchtigkeit.

.....

Le triporteur Carapine est la nouvelle réinterprétation du triporteur traditionnel réfrigéré dont les bacs à glaces sont identiques à ceux du triporteur Classique, dont il partage la même philosophie constructive et le design rétro avec en plus les avantages du système à bacs du modèle Carapine, ce qui permet une conservation excellente de la glace et une meilleure stabilité de la température du produit surtout en situations de température et humidités particulièrement importantes.

.....

El “Carrettino Carapine” es la nueva reinterpretación del tradicional carrito refrigerado con envases que comparte con el “Carrettino Classico” la filosofía constructiva y el estilo antiguo más las ventajas del sistema con envases que permite una perfecta conservación del helado y una temperatura constante del producto, especialmente en situaciones de temperatura e humedad complicadas.









ISA







Il Carrettino  
= CARAPINE =

11



# Autentico FASCINO RETRÒ

Tutti i dettagli del Carrettino Classico e Carapine sono stati progettati e realizzati per mantenere alto il livello di servizio, il comfort dell'operatore e l'efficienza in ogni condizione ambientale senza rinunciare all'armonia estetica, alla cura artigianale del dettaglio e al fascino di un'atmosfera unica che solo il Carrettino può raccontare.

12

.....  
All the details of the Classic Cart and the Carapine have been designed and manufactured to maintain a high level of service, operator comfort and efficiency in all environmental conditions without sacrificing the esthetic harmony, the craftsmanship and the unique charm that only the ISA ice cream cart can convey.

.....  
Alle Details von "Carrettino Classico" und "Carapine" wurden geplant und hergestellt, um eine Servicequalität, Bedienkomfort und Effizienz ein in allen Umgebungsbedingungen zu halten, ohne die ästhetische Harmonie, die handwerkliche Sorgfalt des Details und den Reiz einer einzigartigen Stimmung zu verzichten. Nur die "Carrettino" kann das erzählen.

.....  
Toutes les caractéristiques des triporteurs Classique et Carapine, ont été projetés et réalisés pour garder un niveau de service élevé, le confort de l'opérateur et l'efficacité en toute condition ambiante sans renoncer à l'harmonie esthétique, au soin artisanal du détail et au charme d'une atmosphère unique que seul le triporteur peut nous révéler.

.....  
Todos los detalles del "Carrettino Classico" y el "Carrettino Carapine" han sido proyectados y realizados, para mantener un estándar de servicio alto, el confort del operador y la eficiencia en cualquier condición ambiental sin renunciar al armonía estética con detalles de artesanía, una fascinación que solo el "Carrettino" puede describir.



Tenda parasole in tessuto, con sostegni in acciaio al carbonio, ripiegabile  
Fabric awning with carbon steel supports  
Auvent en tissu, avec des supports en acier au carbone  
Sonnenschutzgewebe, mit Stützungen aus Kohlenstoffstahl  
Tienda parasol en tela, con sostén en carbono de acero.

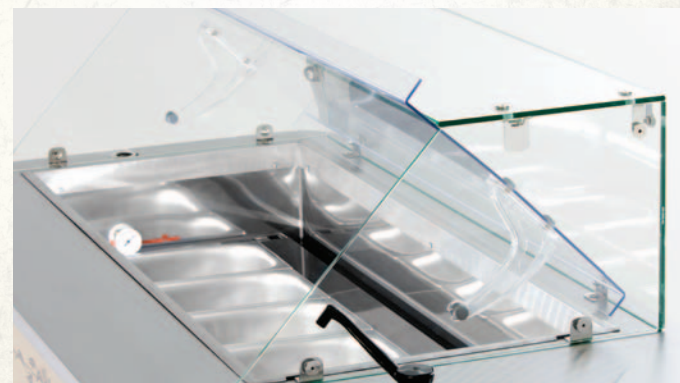

Chiusura posteriore della vasca gelato con ribaltina (classic)  
Rear basin closure with drop-down work surface (classic)  
Retour fermeture de la baignoire de crème glacée avec porte (classique)  
Zurück Schließung der Wanne Eis (klassisch)  
Cerradura posterior del envase de la heladera con cierre inclinado (clasico)





Rubinetto lavaporzionate  
Ice cream scoop washing tap  
Rince cuillères  
Portionierspüle  
Grifo limpiaporciones



Termometro analogico all'interno della vasca (classico)  
Analog thermometer inside the basin (classic)  
Thermomètre analogique à l'intérieur du bassin (classique)  
Analogisches Thermometer in der Wanne (klassisch)  
Termómetro analógico al interno del envase (clasico)



Pozzetto per carapine da 7,5 Lt con riserva  
Counter well with a capacity of eight 7.5 liter circular tubs  
Puit pour bacs de 7,5 litres avec réserve  
Brunnen mit Reserve für Carapine von 7,5 Liter  
Cabina para envases de 7,5lt con reserva



Sistema di illuminazione a led (classico)  
LED lighting system (classic)  
Système d'éclairage LED (classique)  
Ledbeleuchtung (klassisch)  
Sistema de iluminación led (clasico)



Vano tecnico  
Storage compartment  
Compartment technique  
Technischer Raum  
Vano técnico



Castello vetri smontabile per una pulizia ottimale  
Frame with removable glass panels for optimal cleaning  
Cadre en verre amovible pour un nettoyage optimal  
Die Glasstruktur ist zerlegbar um eine optimale Reinigung zu erschaffen  
Castillos de vidrios descomponibles para una mejor limpieza



Ruota anteriore pivotante con freno di stazionamento  
Pivoting front wheel with brake  
Roue avant tournant avec frein  
Drehbarer Vorderreifen mit Bremse  
Rueda anterior rodante con freno de detención



Regolazione elettronica della temperatura  
Electronic temperature regulation  
Température électronique  
Elektronische Regulierung der Temperatur  
Regulador electrónico de la temperatura



## Il Carrettino CLASSICO

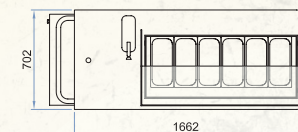
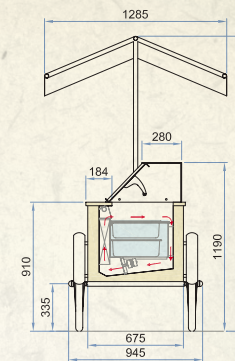
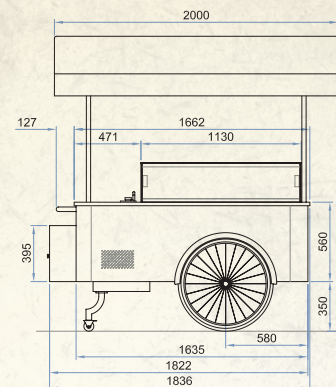

14

## Il Carrettino CARAPINE

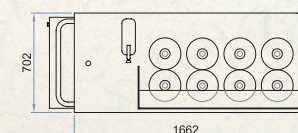
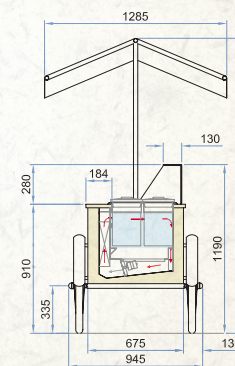
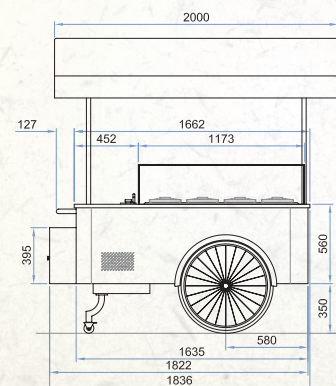

ISO 14064

La ISA S.r.l. nell'ambito del continuo miglioramento del prodotto, si riserva il diritto di modificare in qualsiasi momento, senza preavviso, le caratteristiche tecniche ed estetiche dei propri modelli.

In the interest of continual product improvements, ISA S.r.l. reserves the right to make changes in technical specifications and accessories at any moment and without prior notice.

© 2016 - ISA S.r.l. - Tutti i diritti riservati







## Classico

## Carapine

### CARATTERISTICHE TECNICHE / TECHNICAL FEATURES

<b>DIMENSIONI ESTERNE (mm)</b> External dimensions (mm)	2033x1285x2080,6 (con tenda / with tent)  1832,5x945x1175 (senza tenda / without tent)	2033x1285x2080,6 (con tenda / with tent)  1832,5x945x1175 (senza tenda / without tent)
<b>CAPACITÀ (Lorda/netta)</b> Capacity (gross/net)	260 / 104 lt	260 / 104 lt
<b>PESO NETTO</b> Net weight	205 kg	205 kg
<b>REFRIGERANTE</b> Refrigerante	R404A	R404A
<b>REFRIGERAZIONE</b> Refrigeration	Ventilata / Ventilated	Ventilata / Ventilated
<b>CLASSE CLIMATICA</b> Climatic class	4	4
<b>CONDIZIONI AMBIENTALI</b> Operating conditions	30 °C / 55 %RH	30 °C / 55 %RH
<b>TEMPERATURA PRODOTTO</b> Product temperature	-16 / -14 °C	-16 / -14 °C
<b>COMPRESSORE</b> Compressor (type)	1 Ermetico / 1 Hermetic	1 Ermetico / 1 Hermetic
<b>SBRINAMENTO</b> Defrost	Gas caldo / Hot Gas	Gas caldo / Hot Gas
<b>ALIMENTAZIONE</b> Power supply	230 V / 1 Ph / 50 Hz	230 V / 1 Ph / 50 Hz
<b>ASSORBIMENTO ELETTRICO</b> Electrical input (standard)	500 W / 2,8 A	500 W / 2,8 A

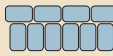
### COMPONIBILITÀ VASCHETTE / CONTAINER SETUP

<b>5 Lt</b> 360x165x120h		6+6  Doppia fila di riserva / Piled up double row	-
<b>4,75 Lt</b> 260x157x170h		10 	-
<b>7,5 Lt</b> Ø200x249h		-	8

## Colori disponibili

Available colors

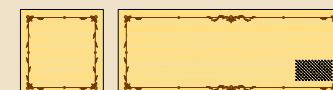

Classic

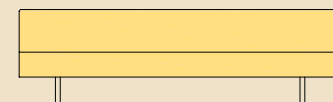

Brown

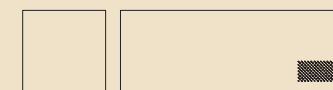
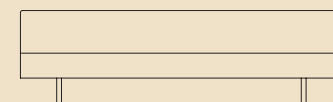

White





**ISA S.r.l.**

via del Lavoro 5  
06083 Bastia Umbra PG  
Italy

T. +39 075 801 71  
F. +39 075 800 09 00  
E. [customerservice@isaitaly.com](mailto:customerservice@isaitaly.com)

**[www.isaitaly.com](http://www.isaitaly.com)**